

PRIMER TRAINER

ASSEMBLY MANUAL

For Revision 1 PRIMER boards

**Copyright 1991-2002 EMAC INC.
UNAUTHORIZED COPYING, DISTRIBUTION,
OR MODIFICATION PROHIBITED
ALL RIGHTS RESERVED**

MANUAL REV. 5.1

**PRIMER TRAINER WARRANTY, RETURN POLICY,
AND LIABILITY DISCLAIMER**

I. WARRANTY

This limited warranty is given to you by EMAC Inc.

This warranty extends only to the original customer purchase of the product.

What the warranty covers and how long:

If this product was purchased assembled and is defective in material or workmanship, return the product within one (1) year of the original date of purchase, and we will repair or replace it (with the same or an equivalent model), at our option, with no charge to you. If this product was purchased unassembled and contained defective parts, we will replace the defective part(s) for a period of 30 days from the original date of purchase. Return the product or defective parts to EMAC for replacement.

How to exercise your warranty or obtain service:

You may arrange for service or for warranty repair by obtaining a Return Authorization Number and then shipping your Product to EMAC Inc.

There will be no charge for warranty service except for your PREPAID shipping cost to our site. We suggest that you retain the original packing material in case you need to ship your product. When returning your Product to our site, please be sure to include:

1. Name
2. Address
3. Phone Number
4. Dated Proof of Purchase (required)
5. A description of the operating problem
6. Serial Number (if available)

We cannot assume responsibility for loss or damage during shipping.

After we repair or replace (at our option) your Product under warranty, you will be shipped the Product at no cost to you.

What this Warranty does not cover:

This warranty does not cover damage resulting from accidents, alternations, failure to follow instructions, incorrect assembly, misuse, unauthorized service, fire, flood, acts of God, or other causes not arising out of defects in material or workmanship.

What we will not do:

WE WILL NOT PAY FOR LOSS OF TIME, INCONVENIENCE, LOSS OF USE OF THE PRODUCT, OR PROPERTY DAMAGE CAUSED BY THIS PRODUCT OR ITS FAILURE TO WORK OR ANY OTHER INCIDENTAL OR CONSEQUENTIAL DAMAGES.

THIS WARRANTY SETS FORTH ALL OUR RESPONSIBILITIES REGARDING THIS PRODUCT. REPAIR OR REPLACEMENT AT AN AUTHORIZED SERVICE LOCATION IS YOUR EXCLUSIVE REMEDY. THIS WARRANTY IS THE ONLY ONE WE GIVE ON THIS PRODUCT. THERE ARE NO OTHER EXPRESS OR IMPLIED WARRANTIES INCLUDING, BUT NOT LIMITED TO, MERCHANTABILITY AND FITNESS FOR A PARTICULAR PURPOSE, FROM EMAC INC.

Other Conditions:

If we repair your product, we may use reconditioned replacement parts or materials. If we choose to replace your product, we may replace it with a reconditioned one of the same or equivalent model. Parts used in repairing or replacing the product will be warranted for one (1) year from the date that the product is returned. Product or parts deemed not defective will be replaced or repaired and shipped at your cost.

State Law Rights:

Some states do not allow limitations on how long an implied warranty lasts or the exclusion or limitation of incidental or consequential damages, so the above exclusion or limitations may not apply to you.

This warranty gives you specific legal rights, and you may also have other rights which vary from state to state.

PRIMER parts have been carefully packed, but should there be a shortage of parts, wrong parts, or defective parts, EMAC will supply replacement parts at no charge.

MISSING PARTS

If parts are found missing, refer to the "PRIMER PARTS PACKING LIST AND SHORTAGE REQUEST SHEET" packed with your PRIMER kit. The "PACK" column was checked off by the packer as your kit was packaged. For the part(s) you believe are missing, enter the number of missing part(s) in the "SHORT" column for that part. At the end of the form, fill out your name, address, and phone number, then mail the form to EMAC within seven (7) days after receipt of the PRIMER to the address shown below.

EMAC, INC.
P.O. BOX 2042
CARBONDALE, IL 62902

A WORD ABOUT SAFETY

In the following pages, you will assemble the parts kits for the PRIMER. In doing so, you will be using tools that may present a danger of injury to those who are careless. The most prevalent danger is eye injury. You will be using diagonal wire cutters to clip the excess component leads as each component is soldered. The cutters will throw wire bits in all directions as leads are clipped. These lead clippings sometimes achieve high velocity, and may strike your eye. Wearing of safety glasses by you and others present in the room will reduce the risk of injury.

Another hazard may be burns. You will be extensively using a soldering iron, so be careful where you set it down. Make sure it will not roll off the table, as it may fall on your leg, etc, or you may instinctively grab for it as it falls, and burn yourself.

Preferably, do the assembly on a fire-resistant, non electrically conductive surface, such as a Formica table top. Metal benches are fire resistant, but pose a shock hazard when working with electrical devices. Never leave the soldering iron plugged in when unattended. Children or pets may accidentally knock it off the table, where it may cause burns or start a fire.

Some of the parts have sharp points. The header connectors used may pierce skin if handled carelessly.

Always work in a well ventilated room, especially when using any cleaning solvents. Practicing simple, sane safety measures will allow you to avoid injury while assembling, testing, and using the PRIMER, or any other electronic assembly.

PRIMER TRAINER ASSEMBLY INTRODUCTION

In this part of the PRIMER ASSEMBLY MANUAL we will outline assembly techniques and component identification. The techniques described here are common to all electronic assemblies.

Prior to assembling the PRIMER kit, it is suggested that you identify the components and separate them into groups, to facilitate easier assembly into the PRIMER board. An empty egg carton may be useful for this purpose. On the following pages are drawings of typical components, Integrated Circuits (ICs), capacitors, resistors, etc. Also there is a checklist of the components packed in your PRIMER kit. The kits are supplied with a separate packing list, checked by the packer as components were issued. On your list, check off each item as you identify each component. Remember, the parts you receive will depend on the options ordered.

Should you have questions or comments about the accuracy or procedures of this manual, please feel free to write or call EMAC.

COMPONENT IDENTIFICATION

The PRIMER is made up of a variety of electronic components, and this section is to help you identify and count them.

The capacitor types used here are disc, monolithic, and radial lead electrolytic. The values of capacitors and type number of integrated circuits are printed directly on the component. Resistors however, use a color coding scheme to identify them. Holding the resistor as shown in the figure, IDENTIFICATION DRAWING 1, the color band at the left is a value digit, and the next band to the right is the next least significant digit. The third band is a decimal multiplier. The fourth band signifies the tolerance of the resistor. The resistors used in the PRIMER are all 5% tolerance, to help simplify identification.

All ICs used on the PRIMER will be socketed, to allow easy replacement should there be a bad one or you accidentally ruin one. IDENTIFICATION DRAWING 2 shows the orientation of the pins on a typical IC, and pin orientation on sockets as well. When these parts are inserted into the board, the ICs must be oriented properly, to match up with the silkscreen outline on the board. Follow the materials checklist to identify the components, and sort them as you wish, to facilitate easy installation. The following pages contain illustrations of the components to assist in identification.

IDENTIFICATION DRAWING 1

CAPACITOR IDENTIFICATION

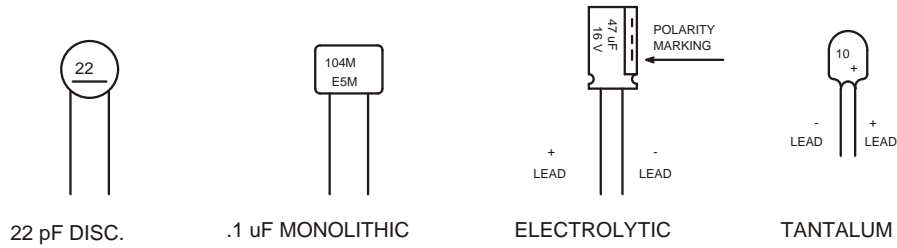

RESISTORS

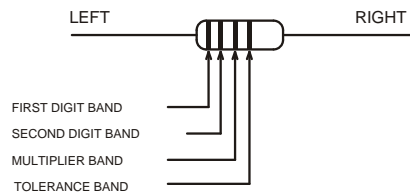

RESISTOR COLOR CODE TABLE

COLOR	VALUE
BLACK	0
BROWN	1
RED	2
ORANGE	3
YELLOW	4
GREEN	5
BLUE	6
VIOLET	7
GRAY	8
WHITE	9
GOLD	.10 OR 5%
SILVER	.01 OR 10%
NO BAND	20%

VALUES USED ON THE PRIMER :

- 56 OHM : GREEN BLUE BLACK GOLD
- 2.2 KOHM : RED RED RED GOLD
- 4.7 KOHM : YELLOW VIOLET RED GOLD
- 15 KOHM : BROWN GREEN ORANGE GOLD
- 33 KOHM : ORANGE ORANGE ORANGE GOLD
- 100 KOHM : BROWN BLACK YELLOW GOLD
- 200 KOHM : RED BLACK YELLOW GOLD

NOTE : 33 OHM USED ON REV 0 PRIMERS ONLY.
56 OHM RESISTORS USED ON REV 1.

RESISTOR NETWORKS

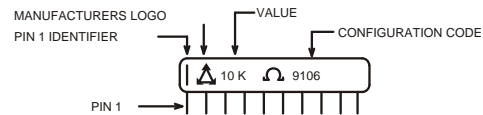

10 K 10 LEAD SHOWN.

THERE IS A 1 K 10 LEAD, AND 1 K 8 LEAD NETWORK USED ON THE PRIMER, TOO.

IDENTIFICATION DRAWING 2

TYPICAL INTEGRATED CIRCUIT

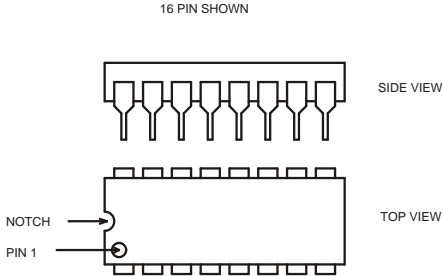

CRYSTAL

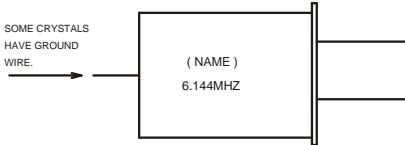

DIODE

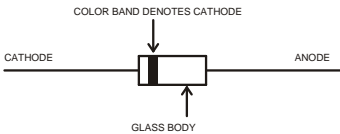

TYPICAL I.C. SOCKET

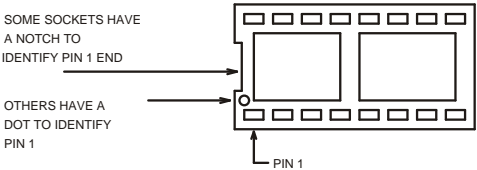

TRANSISTOR (S)

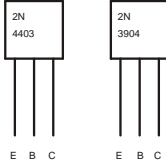

CONNECTOR (HEADER)

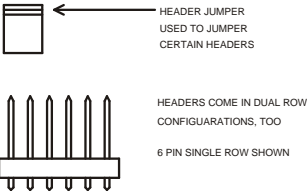

TYPICAL DIPSWITCH

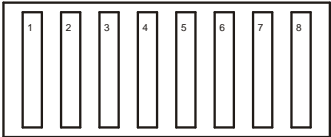

SPEAKER ELEMENT

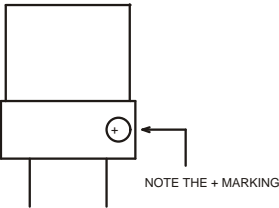

LEDS

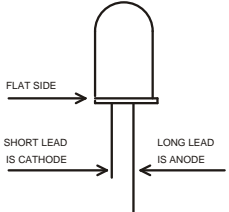

IDENTIFICATION DRAWING 3

POWER JACK

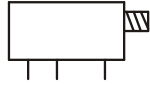

7 SEGMENT DISPLAY

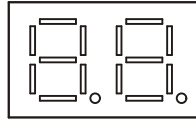

HEATSINK



REGULATOR

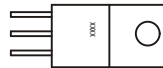

PUSHBUTTON, TINY

UNDER MAGNIFYING GLASS

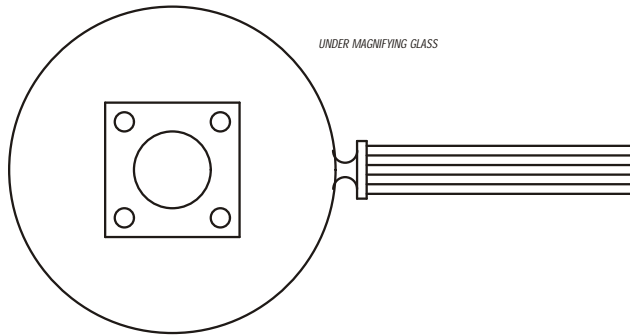

MATERIALS CHECKLIST

<u>CHECK</u>	<u>QUANTITY</u>	<u>DESCRIPTION</u>	<u>Part number</u>
[]	1	PRIMER Blank printed circuit board	01-7400
[]	3	Sockets, 40 pin dip	02-0010
[]	1	Socket, 28 pin dip	02-0012
[]	1	Socket, 20 pin dip	02-0014
[]	1	Socket, 18 pin dip	02-0015
[]	2	Sockets, 16 pin dip	02-0016
[]	3	Sockets, 14 pin dip	02-0017
[]	1	Socket, 8 pin dip	02-0018
[]	1	IC, 8085	06-1203
[]	1	IC, 8155	06-1211
[]	1	IC, 8279	06-1225
[]	1	IC, UDN2981A	06-0502
[]	1	IC, 74HC373	06-0025
[]	1	IC, 74HC139	06-0017
[]	1	IC, 74LS138	06-0064
[]	1	IC, 74HC08	06-0004
[]	1	IC, 74HC14	06-0006
[]	1	IC, 74LS90	06-0063
[]	1	IC, LM35806-0302	
[]	8	120 ohm 5% 1/4 W resistors	10-0051
[]	3	2.2 Kohm 5% 1/4 W resistors	10-0081
[]	1	4.7 Kohm 5% 1/4 W resistor	10-0089
[]	1	15 Kohm 5% 1/4 W resistor	10-0101
[]	1	33 Kohm 5% 1/4 W resistor	10-0109
[]	6	100 Kohm 5% 1/4 W resistors	10-0121
[]	7	200 Kohm 5% 1/4 W resistors	10-0128
[]	1	1 Kohm X7 8 Lead R-network	10-2202
[]	1	1 Kohm X9 10 Lead R-network	10-2302
[]	1	10 Kohm X9 10 Lead R-network	10-2303
[]	1	22 pF 50 V Disc Capacitor	09-0030
[]	9	.1 uF 50 V Monolithic Cap.	09-0550
[]	1	10 uF 16 V Tantalum Capacitor	09-0734
[]	1	47 uF 16 V Electrolytic Cap.	09-0803
[]	1	220 uF 16 V Electrolytic Cap.	09-0805
[]	1	50 pin (2x25) connector	20-0350
[]	1	24 pin (2x12) connector	20-0324
[]	1	5 pin connector	20-0205
[]	2	3 pin connector	20-0203
[]	1	Crystal, 6.144 MHz	14-0005
[]	1	Diode, 1N914	04-0001
[]	1	Speaker Element	18-0002
[]	1	Transistor, NPN, 2N3904	05-0001
[]	6	Transistor, PNP, 2N4403	05-0004
[]	8	LED, RED 07-0001	
[]	3	LED Display, 7 segment 2 dig.	07-0301
[]	1	Dipswitch, 8 station	12-0018
[]	1	Power Jack	02-0070
[]	4	Header Jumpers	02-0700
[]	1	IC, LM7805 (5V Regulator)	06-0408
[]	1	Heatsink 03-0201	
[]	1	Screw, 6-32 x 1/4"	03-0031
[]	1	Nut, hex, 6-32	03-0050
[]	5	Rubber Feet, Square 1/2"	03-0300

If you have the standard option board, you will have 21 tiny pushbuttons. If you have a board with the keypad upgrade, you will have only one button, and two keypads. Check them off here.

<u>CHECK</u>	<u>QUANTITY</u>	<u>DESCRIPTION</u>	<u>Part number</u>
[]	21	Pushbutton, tiny	12-0030
		----- OR -----	
[]	1	Pushbutton, tiny	12-0030
[]	1	Keypad, 1x4	12-0054
[]	1	Keypad, 4x4	12-0060

If you have ordered one of the UPGRADE OPTIONS, (expanded memory and communication) the following parts should also be present.

[]	4	2.2 uF 16 V Tant. Cap.	09-0740
[]	1	Socket, 14 pin dip	02-0017
[]	1	Socket, 16 pin dip	02-0016
[]	2	Sockets, 28 pin dip	02-0012
[]	1	14 pin (2x7) connector	20-0314
[]	1	Header jumper	02-0700
[]	1	Connector, DB-9 Female	02-0089
[]	1	IC, MAX-232 or ICL-232	06-0508
[]	1	IC, CD4024	06-0051
[]	1	IC, 82C51A (UART)	06-1216
[]	1	32K CMOS SRAM	06-0723
[]	1	SMARTSOCKET (standard upgrade)	21-0100
		----- OR -----	
[]	1	SMARTCLOCK (deluxe upgrade)	21-0200

Depending on the software option ordered, you will have one or more EPROM chips, with the type and version number(s) printed on them. There will always be at least one EPROM with each kit. Check the type of EPROM(s) supplied here.

[]	MOS (Standard Monitor Operating System)
[]	EMOS (Enhanced Monitor Operating System)
[]	MTBASIC
[]	E-FORTH

SOLDERING TECHNIQUES

The PRIMER's Components, as well as most electronic components on most electronic assemblies are soldered in place. Soldering provides both physical and electrical connection of the components to the Printed Circuit board. The printed circuit board makes all the electrical interconnections between the components, and supports the components into a single, rigid and reliable assembly.

There are many kinds of solder, for a broad range of applications. The kind of solder used for the construction of the PRIMER should be "60/40" rosin core solder". This type of solder is commonly available at electronic stores. The ratio of lead to tin in the solder as expressed by "60/40" or "50/50", etc., determines its melting point. 60/40 solder is the overall best kind to use in electronic assembly. The "core" of the solder is the kind of flux contained in the solder extrusion. Some solders have a solid core, which means there is no flux built into it. These solders require flux to be added externally. Do not use solid core solder. For electronic use, ROSIN CORE flux is the most common. Never use acid core solder, as acid core solder attacks electronic connections. Rosin type fluxes are inert when cool, and do not harm connections or components.

If you can get water soluble flux core solder, cleanup of the finished board will be much easier. Standard Rosin Core solder usually requires solvents for clean up.

The flux in solder assists in the metal to metal bonding process, when hot solder is applied to a connection. The flux breaks up oxidation that is present on the metals to be soldered. The surface of metals to be soldered must be clean. Component leads, and the printed circuit board used in the PRIMER are all clean as they are manufactured. However, oxidation films build up quickly after fabrication. When a component is soldered into the board, the solder flux combines with the oxidation to help remove it. However, solder flux cannot remove heavy oxidation or dirt.

Most component leads and printed circuit boards are "Tinned", which means they have a tin coating on them. When the solder is applied, in conjunction with the solder flux, the oxidation film floats off the surface of the metals as they are soldered. Some component's leads are easier to solder than others, principally depending on the quality of their tinning at production.

Soldering requires heat to melt the solder, and provide the energy required to bond the solder to the metals involved. This heat is usually provided by a "soldering iron". There are as many kinds of soldering irons as there are solders. The best kind should be an AC powered soldering iron, about 30 to 40 Watts, with a pencil point tip. A cheap, but well suited soldering iron can be purchased at electronic supply stores for around \$10.00. We recommend that you use a "pencil" grip iron, as they are light weight, and easy to hold. Soldering guns are not recommended for this delicate type of work.

To solder a connection, first have the site prepared by placing the component lead through the hole in the solder pad, ready for soldering. Touch the soldering iron's tip onto the junction of the pad and the lead, and touch the solder itself to the junction at the same time. As the solder melts, feed the solder in. Stop feeding the solder when a suitable "bead" of solder appears, and remove the soldering iron tip as well. The whole process should take only a few seconds, two to three seconds is typical. The finished solder connection should be allowed to cool, so do not allow anything to move for a few seconds. The finished solder connection should be smooth and shiny. Be careful not to make "floating beads", or apply too much solder.

Beware of the "COLD" solder joint. This is a soldered connection that was not heated thoroughly, or the surface of the metals was too dirty to solder. A cold solder joint will often look dull, and if you touch it, it will move, because the solder did not bond correctly. Cold solder joints are a leading cause of circuit failure.

Be careful not to solder a connection too long. If the pad gets overheated, it will lift off from the board. Lifted tracks and pads are difficult to repair. The use of a small tip helps you to place the solder exactly where you want it. When working with small and crowded connections, as you will encounter during assembly, it will be easy to slop solder over from one pad or track to another. This creates a solder "bridge", which is a short circuit. Solder shorts must be removed.

As you solder, you will quickly build up burnt solder slag on the tip of the soldering iron. Have a damp sponge handy, and wipe the soldering tip across the sponge to clean the tip. Some "soldering stations" have a sponge included with them.

If you make a solder bridge or short, wipe the soldering tip on the sponge, and then "pick up" the excess solder with the iron, and wipe it on the sponge, pick up more excess solder from the board, and so on until the solder short is removed.

If possible, practice soldering on some junk circuit assemblies before working on the PRIMER if you haven't done this sort of work before. With a little practice you will soon get a handle on it.

COMPONENT INSTALLATION TIPS

To install an axial leaded component, such as a resistor, bend the leads at right angles to the body of the part. The hole spacing on the primer board is such that you may bend the leads at the body's end directly. From the component side of the board, insert the leads into the solder pad holes for that component, and push the component down to the surface of the board. The component side of the board is the side with the component designator, outlines, and text printed on it. For high quality appearance's sake, be sure the resistor is held flat against the board. Bend the leads outward from each other to hold the component in place until it is soldered.

Radial leaded components, such as the capacitors, are installed in a similar manner, but they won't need their leads to be bent prior to installation. Some of the monolithic capacitors may need to have their leads spread apart, as the board holes are spaced further apart than the component leads actually are. In the case of monolithic and disc capacitors, it is suggested you insert them into the board so the capacitor is about 1/4 inch above the board surface. For electrolytic capacitors, push them all the way down. Be sure to match the polarity of the capacitor to the polarity marked on the board. Many electrolytics have the NEGATIVE side marked by arrows on their body. The POSITIVE side lead is opposite lead. Secure the capacitors in place by bending the leads apart to hold the component prior to soldering.

IC sockets and resistor networks should not have their leads bent prior to soldering. Refer to the appropriate Identification Drawing to determine the pin alignment, and insert the component into the board so that it agrees with the silkscreen outline on the board. IC sockets usually have a white dot, a cutout, or a dimple on them to assist in finding the PIN 1 end. Resistor networks also have a PIN 1 identifier. ICs and Resistor Networks will not function properly if installed incorrectly.

Hold the part against the board with your finger, and "Tack Solder" a couple of the leads to hold the part on the board. Tack soldering is a technique where you apply a little bit of solder to the tip of the soldering iron, then touch the iron to the junction to be soldered. This puts a little spot of solder on the junction, just enough to hold the part lead in place temporarily. Later you can finish soldering the component. Now adjust the part so it is straight and level, re-heating the "tack" as required. Tacking the center lead of resistor networks, and tacking the corners of the IC sockets, will allow you to flip the board over, so the part will not fall out as you finish soldering it. When the installation is satisfactory, you may then finish soldering.

LEDs (Light Emitting Diodes), and LED Displays are installed in a similar manner. For single point LEDs, insert the leads into the holes, and hold the LED about 1/8 inch off the board, and tack solder one of the leads. Flip the board over and set the LED straight up. Then finish soldering the other lead. When it has cooled, finish soldering the first lead.

A properly soldered junction should form a smooth, shiny bead of solder from the component lead to the solder pad, with no gaps, nor swelling over. Be careful to solder quickly, so as not to over heat or melt the part, particularly for ICs and LEDs.

TOOLS

The PRIMER assembly process requires only simple hand tools. Below is a list of the commonly available tools needed.

1. Soldering Iron, 30 to 40 Watt, Pencil tip.
2. Needle nose pliers. (small)
3. Straight blade screwdriver.
4. Diagonal wire cutters. (small)
5. 5/16" Nut driver.
6. Rosin core electronic grade solder. (water soluble type preferred)
7. Safety glasses.

Nice tools to have, but not absolutely necessary :

1. Circuit board holder. (PanaVise, Inc. is a typical vendor)
2. Silicone RTV sealer
3. Silicone thermal (Heatsink) compound

These tools are readily available at electronic stores, and some retail stores.

Let us now proceed to the actual assembly process. Good luck !

In this first part of the PRIMER assembly procedure, we will install all the DIP (Dual Inline Package) IC's. The component placement is pictured in the facing page, Assembly Drawing "A". Place a check mark in each box as each step is completed. Please observe proper polarity, installation, and soldering techniques outlined previously.

Section 1. I.C. sockets.

These sockets should be soldered into the board.

- [] 1. Install a 40 pin DIP socket at position U1.
- [] 2. Install a 40 pin DIP socket at position U4.
- [] 3. Install a 40 pin DIP socket at position U5.
- [] 4. Install a 28 pin DIP socket at position U2.
- [] 5. Install an 18 pin DIP socket at position U6.
- [] 6. Install a 20 pin DIP socket at position U8.
- [] 7. Install a 16 pin DIP socket at position U9.
- [] 8. Install a 16 pin DIP socket at position U7.
- [] 9. Install a 14 pin DIP socket at position U10.
- [] 10. Install a 14 pin DIP socket at position U11.
- [] 11. Install a 14 pin DIP socket at position U12.
- [] 12. Install an 8 pin DIP socket at position U14.

Section 2. I.C. installation.

These components are plugged into the sockets installed in section 1.

- [] 1. Install the 8085 I.C. into socket position U1.
- [] 2. Install the 8155 I.C. into socket position U4.
- [] 3. Install the 8279 I.C. into socket position U5.
- [] 4. Install the EPROM I.C. into socket position U2.
- [] 5. Install the UDN2981A I.C. into socket position U6.
- [] 6. Install the 74HC373 I.C. into socket position U8.
- [] 7. Install the 74HC139 I.C. into socket position U9.
- [] 8. Install the 74LS138 I.C. into socket position U7.
- [] 9. Install the 74HC08 I.C. into socket position U10.
- [] 10. Install the 74HC14 I.C. into socket position U11.
- [] 11. Install the 74LS90 I.C. into socket position U12.
- [] 12. Install the LM358 I.C. into socket position U14.

Make sure each IC and it's socket is oriented so that pin 1 is in the correct position. Please carefully inspect the solder connections for cold solder joints, loose joints, solder shorts, etc. Be sure that no pins are bent under the sockets or under the ICs where they plug into the sockets. If possible, let someone else check your work. Another person's eyes may catch things you may have missed.

Upon successful completion of these two sections, proceed to the next assembly section.

ASSEMBLY DRAWING A - STANDARD IC. AND SOCKET PLACEMENT

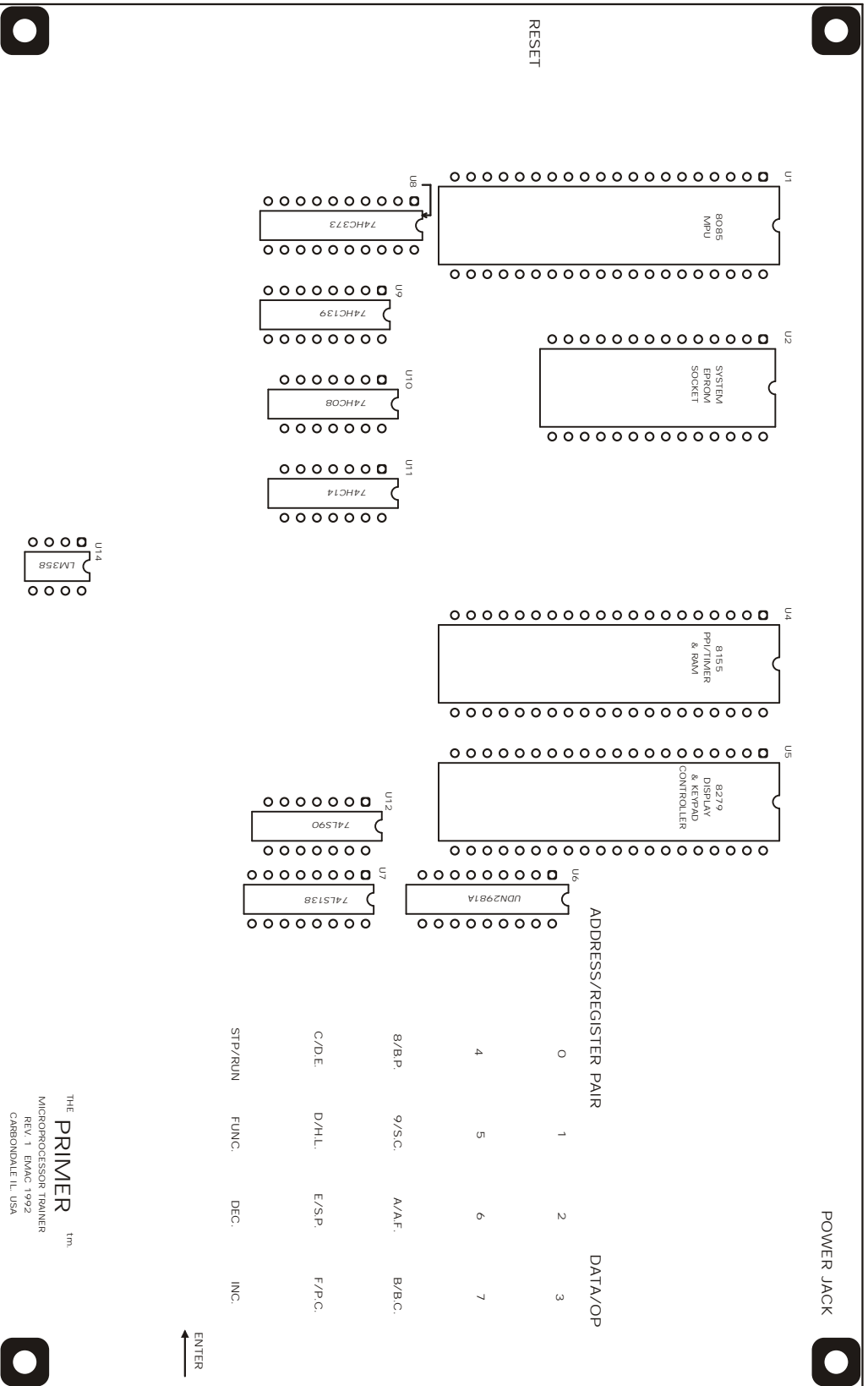

THE PRIMER™
 MICROPROCESSOR TRAINER
 REV. 1 EMAC 1992
 CARBONDALE, IL, USA

In this second part of the PRIMER assembly procedure, we will install all the resistors. Prior to starting this section, use the resistor color code chart to identify the resistor values. Sort them out first, and arrange them in a line across your assembly table in the order they will be installed. This will assist you in quickly and correctly installing them onto the PRIMER. The facing page, Assembly drawing "B", shows the placement layout.

All resistors used in the PRIMER are 5% tolerance, 1/4 Watt resistors.

Section 3. Resistors.

These components are soldered directly into the board.

Bend the leads over to hold the resistors in place, except for the resistor networks, which should be "tack" soldered first.

- [] 1. Install a 33 K ohm resistor at position R1.
- [] 2. Install a 2.2 K ohm resistor at position R2.
- [] 3. Install a 2.2 K ohm resistor at position R3.
- [] 4. Install a 2.2 K ohm resistor at position R4.
- [] 5. Install 120 ohm resistors at positions R5 through R12.
[] R5 [] R6 [] R7 [] R8 [] R9 [] R10
[] R11 [] R12
- [] 6. Install the 10 k ohm, 10 lead resistor network at position R13. Be sure to install pin 1 at the proper location.
- [] 7. Install the 1 k ohm, 10 lead resistor network at position R14. Be sure to install pin 1 at the proper location.
- [] 8. Install a 200 K ohm resistor at position R15.
- [] 9. Install a 200 K ohm resistor at position R16.
- [] 10. Install a 100 K ohm resistor at position R17.
- [] 11. Install a 200 K ohm resistor at position R18.
- [] 12. Install a 100 K ohm resistor at position R19.
- [] 13. Install a 200 K ohm resistor at position R20.
- [] 14. Install a 100 K ohm resistor at position R21.
- [] 15. Install a 200 K ohm resistor at position R22.
- [] 16. Install a 100 K ohm resistor at position R23.
- [] 17. Install a 200 K ohm resistor at position R24.
- [] 18. Install a 100 K ohm resistor at position R25.
- [] 19. Install a 200 K ohm resistor at position R26.
- [] 20. Install the 1 K ohm, 8 lead resistor network at position R27. Be sure to install pin 1 at the proper location.
- [] 21. Install a 100 K ohm resistor at position R28.
- [] 22. Install a 15 K ohm resistor at position R29.
- [] 23. Install a 4.7 k ohm resistor at position R30.

Carefully check the resistors for correct placement, then solder them in fully. Then re-check the soldering as before, for good solder joints. Clip the excess leads.

ASSEMBLY DRAWING B - RESISTOR PLACEMENT

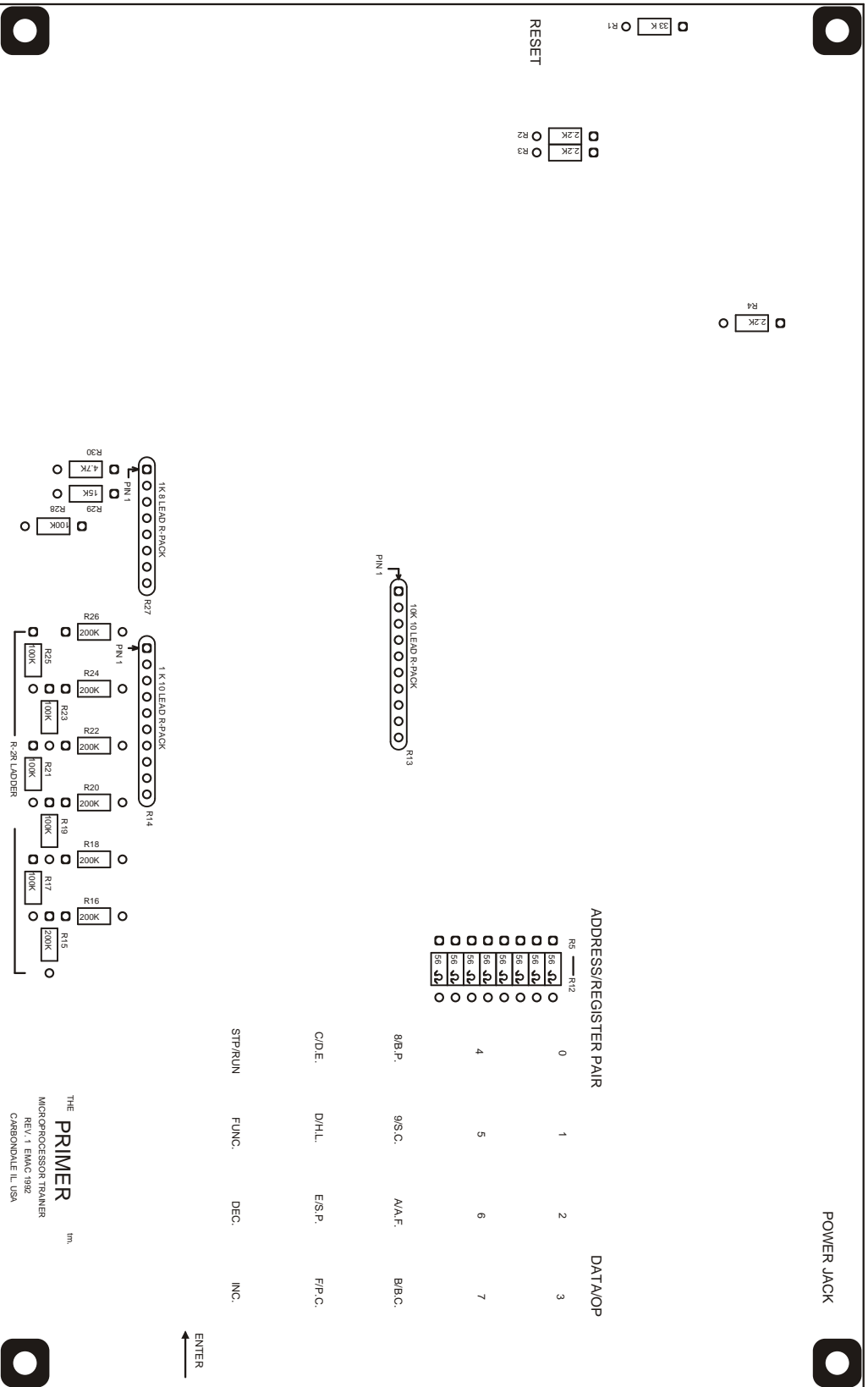

In this third part of the PRIMER assembly procedure, we will install the capacitors for the standard optioned board. Please follow the component identification procedures, and arrange the capacitors in order, to facilitate quick and correct installation of the capacitors. The drawing on the facing page, Drawing "C", depicts the placement of the capacitors.

Section 4. Capacitors.

These components are soldered directly to the board. The same procedure used for installing the resistors may be used, by first installing the component, and bending over the leads to hold it in place. After installing all capacitors, and inspecting for correct placement, they may be soldered all at once, lead clipped, and re-inspected for soldering integrity.

- [] 1. Install a 10 uF 16 volt Tantalum capacitor at position C1. Be sure to note the polarity marked on the board, and place the + side of the capacitor to match.
- [] 2. Install a 22 pF 50 volt disc capacitor at position C3. (Note that the position labeled C2 is not used).
- [] 3. Install a .1 uF 50 volt monolithic capacitor at C4.
- [] 4. Install a .1 uF 50 volt monolithic capacitor at C5.
- [] 5. Install a .1 uF 50 volt monolithic capacitor at C6.
- [] 6. Install a .1 uF 50 volt monolithic capacitor at C7.
- [] 7. Install a 220 uF 16 volt electrolytic capacitor at position C8. Be sure to observe correct polarity.
- [] 8. Install a 47 uF 16 volt electrolytic capacitor at position C9. Be sure to observe correct polarity.
- [] 9. Install a .1 uF 50 volt monolithic capacitor at C10.
- [] 10. Install a .1 uF 50 volt monolithic capacitor at C11.
- [] 11. Install a .1 uF 50 volt monolithic capacitor at C12.
- [] 12. Install a .1 uF 50 volt monolithic capacitor at C13.
- [] 13. Install a .1 uF 50 volt monolithic capacitor at C14.

Upon completion of this section, re-inspect the capacitors for correct placement, and polarity. Finish soldering, clip the excess leads, and inspect the solder connections. Proceed to the next assembly page.

ASSEMBLY DRAWING C - STANDARD CAPACITOR PLACEMENT

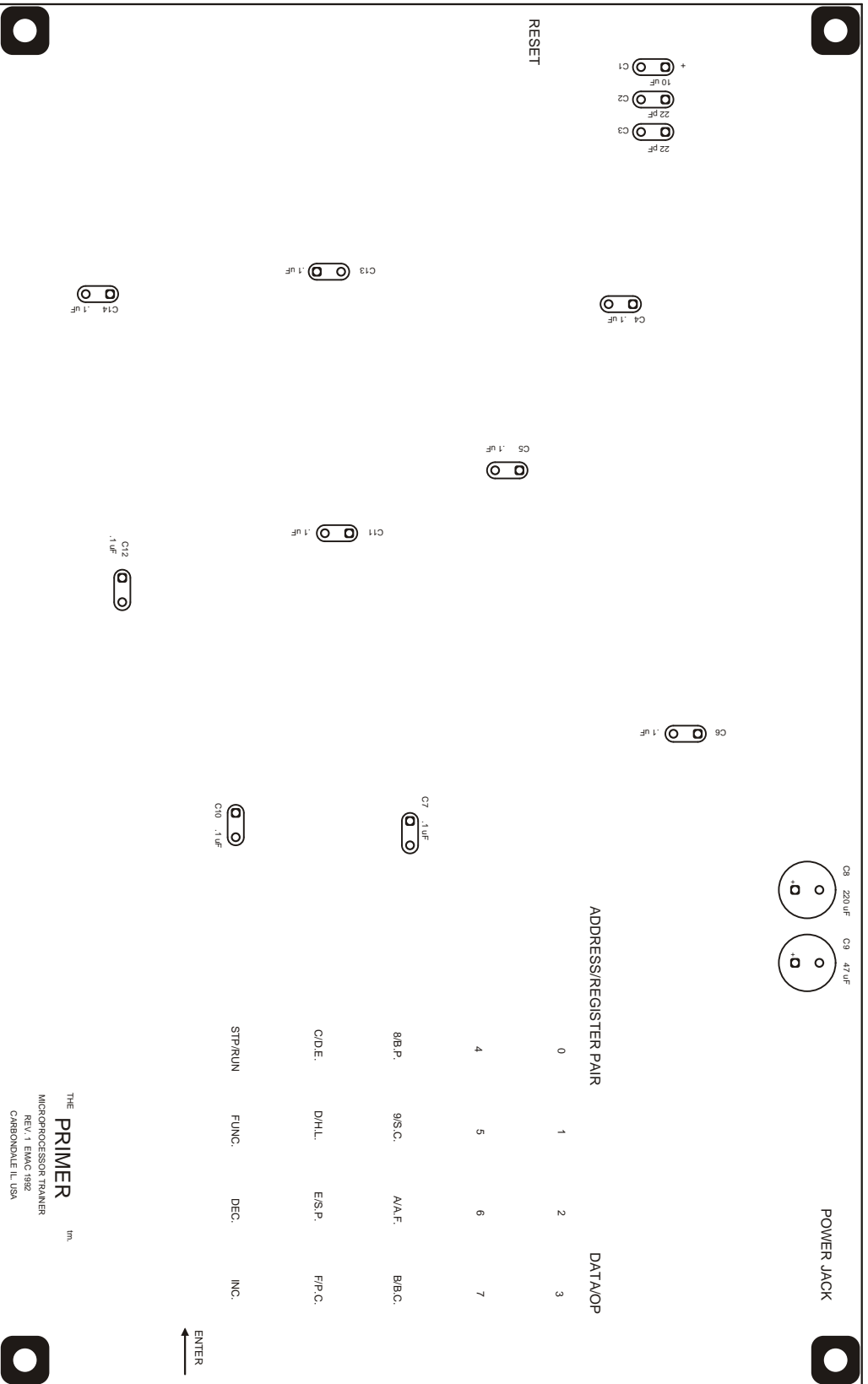

THE PRIMER
 MICROPROCESSOR TRAINER
 REV. 1 EMAC 1992
 CARBONDALE, IL, USA

In this fourth part of the PRIMER assembly procedure, the remaining miscellaneous components of the standard version board will be installed. The facing page, Drawing "D", depicts the placement of components in this phase of assembly.

Section 5. Miscellaneous Components.

Directions for installation will be given part for part when needed.

- [] 1. Install the 50 pin, (dual 25) dual row header connector at position CN1. The part itself is not polarized, it can go in either way. Place the short stakes into the board, and the long ones facing up (the component side). Hold it in place with your finger, while flipping the board over, and tack solder a few pins (not the ones you are holding!). Inspect the connector for proper placement, and be sure it is flat against the board, standing straight up. If all is correct, finish soldering CN1.
- [] 2. Install the 24 pin (dual 12) dual row header connector at position CN3. Use the same procedure outlined previously.
- [] 3. Install the 5 pin single row header connector at position OJ1, using the same procedure as above.
- [] 4. Install a 3 pin single row header connector at position OJ2.
- [] 5. Install a 3 pin single row header connector at position OJ3.
- [] 6. Install the 6.144 MHZ Crystal at position Y1, as shown in the assembly drawing. The Crystal is not polarized, and may be put in either way. Some crystals have a tail used to strap the crystal in place. If you have a crystal such as this solder the tail in the hole provided. If the crystal does not have a tail then use a piece of discarded capacitor lead, to strap the crystal down. Solder the crystal and the strap leads. Solder the strap to the crystal. Cut off the excess leads. (See assembly drawing "D").
- [] 7. Install the diode, type 1N914 (or 1N4148) at position D1. Note the polarity of the diode, as shown in IDENTIFICATION DRAWING 2. The thick band on the silkscreen is the Cathode end. Solder and clip excess leads.
- [] 8. Install the reset push button at position PB1 (RESET). This push button is not polarized, and may go in either way. The holes in the printed circuit board are in a rectangular pattern to match the pushbutton switch. After installing the pushbutton switch, solder it in place.
- [] 9. Install the speaker element at position SPK1. There is a + mark on it, align it with the + on the board. Solder the speaker element in place, being sure it is snugly placed against the board first. For a more secure attachment of the speaker, you may spread some silicone sealer on the underside of the speaker element prior to installing it.

ASSEMBLY DRAWING D - MISCELLANEOUS COMPONENTS

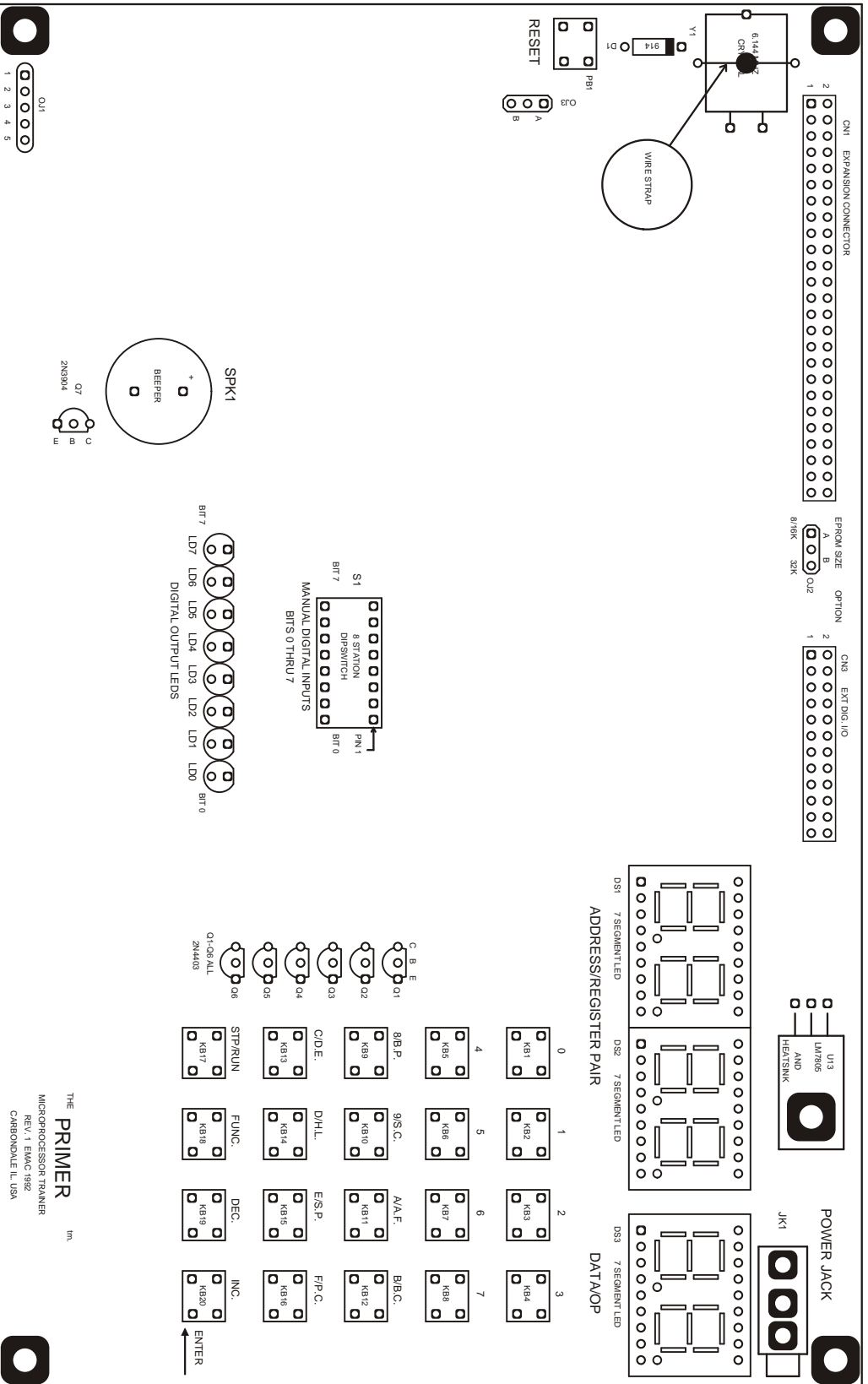

THE **PRIMER**™
MICROPROCESSOR TRAINER
REV. 1 EMAC 1992
CARBONDALE, ILL. USA

- [] 10. Install the 2N3904 Transistor (NPN) at position Q7. Note the board silkscreen pattern has a flat mark on it. Place the transistor in the board so that the flat side of the transistor, and the flat side of the silkscreen match. Set the transistor leads into the holes so the transistor is about 1/4 inch above the board. Solder this component in place, and clip the leads.
- [] 11. Install the 8 Station Dipswitch at position S1. The switch position number one will be on the right, as seen in assembly drawing "D". On some switches the numbers will be upside down. We're sorry about that, but standard switch numbering is reversed relative to the hexadecimal readout convention used on the PRIMER. Make sure the switch is snug against the board, oriented correctly, then "tack solder" it into place. Clip the leads flat to the board. Clipping the leads flat to the board with the switch in place prior to soldering will expose clean metal, and the solder will flow more easily. "finish" solder the switch into place.
- [] 12. Install the 8 LEDs into positions LD0 through LD7. This will be quite tricky to do well. The LED's have two leads, one long and one short. The long lead is the anode. The anode lead (long) must go into the ROUND hole in each location. The short lead is the LED's cathode, and must go into the SQUARE hole. If you are lucky enough to have LED's that have a flat side on their base, (many do not) the flat side on the part will line up with the flat side on the silkscreen pattern. The LEDs will not work if they are in backwards.

When installing them, try to hold the LED's body about 1/8 inch above the board, and tack solder ONE of the leads. If one is available, use a small circuit board holder to support the board while you hold the LED in one hand, while soldering with the other. Repeat this procedure for the rest of the LEDs. Now look at the LED's from the edge of the board, and also from directly overhead. Bend the LED's around laterally to align them into a straight row. If an LED is too high or too low, reheat the lead, and adjust the height.

When the LED's are satisfactorily in place, solder the other lead of each one. Wait until that lead is cool before you re-solder (finish soldering) the first lead, or else the LED will move. Clip the leads on that LED, to get the leads out of your way. Repeat until all 8 are secured in place.

[] LD0 [] LD1 [] LD2 [] LD3 [] LD4
 [] LD5 [] LD6 [] LD7

- [] 13. Install a 2N4403 (PNP) transistor at positions Q1, Q2, Q3, Q4, Q5, and Q6. Use the same procedure for transistor installation as outlined previously for Q7.

[] Q1 [] Q2 [] Q3 [] Q4 [] Q5 [] Q6

- [] 14. Install the power jack at position JK1. The connector should face outward of the board as shown in assembly drawing "D". Hold the part snugly against the board, and solder it into place.

- [] 15. Install the LM7805 Voltage Regulator and heat sink assembly at position U13. First, form the leads of the regulator with needle nose pliers. Hold the regulator with the metal tab against the board, and judge where the leads should be bent. Then pass the 6-32 x 1/4 screw through the hole in the regulator's tab, and place this assembly onto the heat sink, passing the screw through the heat sink's hole. If you have silicone heat sink paste handy, smear some onto the regulator's tab before you attach it to the heat sink.

Now attach this regulator/heat sink/screw assembly onto the board, while pushing the leads through their holes at the same time (which is why you pre-formed the leads a moment ago). Place the 6-32 nut onto the bit of screw sticking out of the back side (solder side) of the board and screw it on. Straighten out the regulator and heat sink, and hold the screw with a screwdriver, while tightening the nut with a nut driver. We recommend you tighten the nut, rather than the screw, so the regulator and heat sink doesn't move while you tighten them down. When the regulator assembly is completed, solder the three leads to the board. Clip off excess leads if necessary.

[] Regulator U13
[] Heat sink
[] screw
[] nut

- [] 16. Install the seven segment display LEDs, DS1, DS2, and DS3. Observe the orientation of the LEDs on assembly drawing "F", and place the displays onto the board in the same way. The decimal points will be on the bottom right of each digit. Hold each display snugly against the board, and solder it in place. Clip excess leads if necessary.

[] DS1 [] DS2 [] DS3

- 17. At this point in the assembly process, the components placed will depend on the option package(s) ordered.

- [] A. If you did not order the optional keypads in place of individual buttons, you should install the 20 push buttons provided at positions KB1 through KB20. The buttons are not polarized, so they have no particular requirements for installation. Hold the buttons snugly against the board prior to soldering. As each key button is installed, solder it in place. Assembly Drawing "D" details their locations.

[] KB1 [] KB2 [] KB3 [] KB4 [] KB5
[] KB6 [] KB7 [] KB8 [] KB9 [] KB10
[] KB11 [] KB12 [] KB13 [] KB14 [] KB15
[] KB17 [] KB18 [] KB19 [] KB20

[] B. If you have the keypad option, install the 4X4 keypad, and the 1X4 keypad, at positions KP1 and KP2. Install KP2, the 1X4 keypad first. Carefully observe the alignment of the 4X1 keypad with the silkscreen on the board. The 1X4 keypad, will help guide the 4X4 keypad KP1 into place. The 4X4 will not fit easily if it is upside down, as KP2 is already in place. Assembly drawing "F" details the optional keypad placement. Once the keypads are correctly installed, hold them snugly against the board, and solder them in. Clip the leads if necessary.

[] KP2 [] KP1

[] 18. Place header jumpers at OJ1, positions 1-2, and 4-5. also place a jumper at OJ2, position "A", (8/32K) and lastly, place a jumper at OJ3, position "A".

[] OJ1, 1-2 [] OJ1, 4-5 [] OJ2, A [] OJ3, A

CONGRATULATIONS!

You have now completed assembly of the standard PRIMER. If you haven't ordered the upgrade option, (communication and expanded memory) you may skip ahead to the FINAL ASSEMBLY section. If you do have the upgrade option, continue on with the following assembly steps.

ASSEMBLY DRAWING E - PICTORAL FINISHED STANDARD BOARD

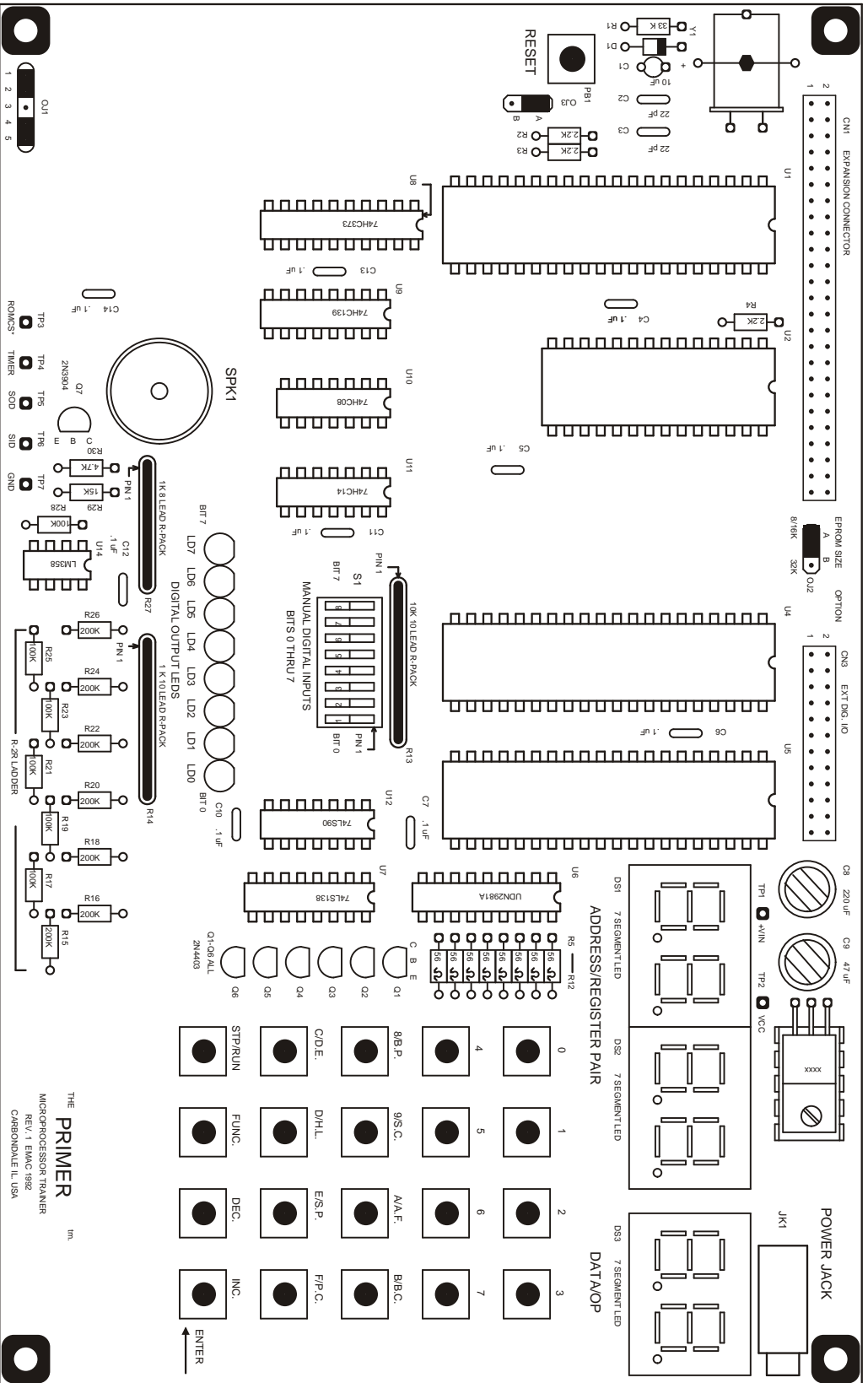

THE PRIMER
MICROPROCESSOR TRAINER
REV. 1 EMAC 1992
CARBONALE ILL. USA

PRIMER 1 PRS
PRR1 PRS1 PS

UPGRADE OPTION ASSEMBLY

If you have ordered the upgrade option, (communication and extra memory option) this fifth section of the assembly procedure needs to be followed. Assembly drawing "F" depicts the components installed in this part of the assembly procedure.

Section 6. Option package installation.

---- 1. Install capacitors at positions C15, C16, C17 and C18. All four of them are 2.2 uF, 16 volt Tantalum capacitors. Be sure to observe the polarization of these capacitors, align the + side of the capacitor with the + marking on the board. Solder them in, and clip the excess leads.

[] C15 [] C16 [] C17 [] C18

[] 2. Install a 16 pin socket at position U15. Hold it snugly against the board, and solder it in.

[] 3. Install the MAX-232, or ICL-232 IC into the socket at U15.

[] 4. Install a 14 pin socket at position U16. Hold it snugly against the board, and solder it in.

[] 5. Install the CD4024 or 74HC4024 IC into the socket at U16.

[] 6. Install a 28 pin socket at position U17. Hold it snugly against the board, and solder it in.

[] 7. Install the 8251A IC into the socket at U17.

[] 8. Install the 14 pin (7 pins x 2 rows) header connector at position JP1. Hold it snugly against the board, and solder it in.

[] 9. Install a header jumper across the "9600" option on JP1. Refer to assembly drawing "F" to see correct placement.

[] 10. Install the DB-9 connector at position CN2. Hold it snugly in place, and solder it in. Clip off excess leads.

[] 11. Install a 28 pin socket at position U3. Hold it snugly in place against the board, and solder it in.

[] 12. Install the 32 K RAMDISK assembly into the socket at U3.

[] 13. Move the jumper, at OJ3, from position "A", to position "B". (This re-arranges the memory map from the standard configuration).

[] 14. If you have an EPROM marked "EMOS" instead of "MOS" then move the jumper at OJ2 to position "B".

Proceed now to the section, "FINAL ASSEMBLY".

ASSEMBLY DRAWING F - OPTIONAL COMPONENTS

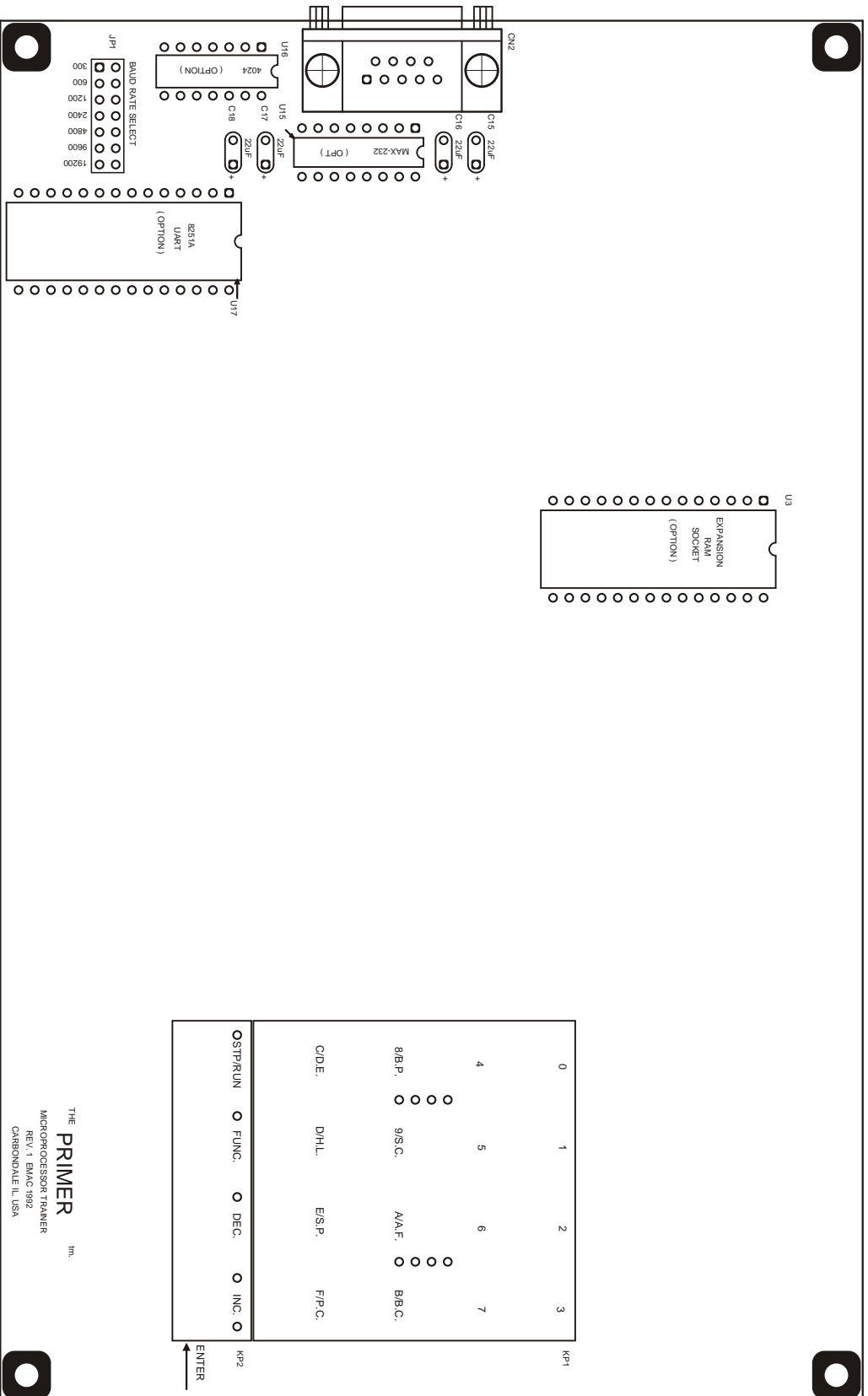

THE PRIMER™
 MICROPROCESSOR TRAINER
 REV. 1 EMI/AC 1992
 CARBONDALE IL USA

ASSEMBLY DRAWING G - COMMUNICATION OPTION AND MEMORY EXPANSION OPTION INSTALLED PICTORAL

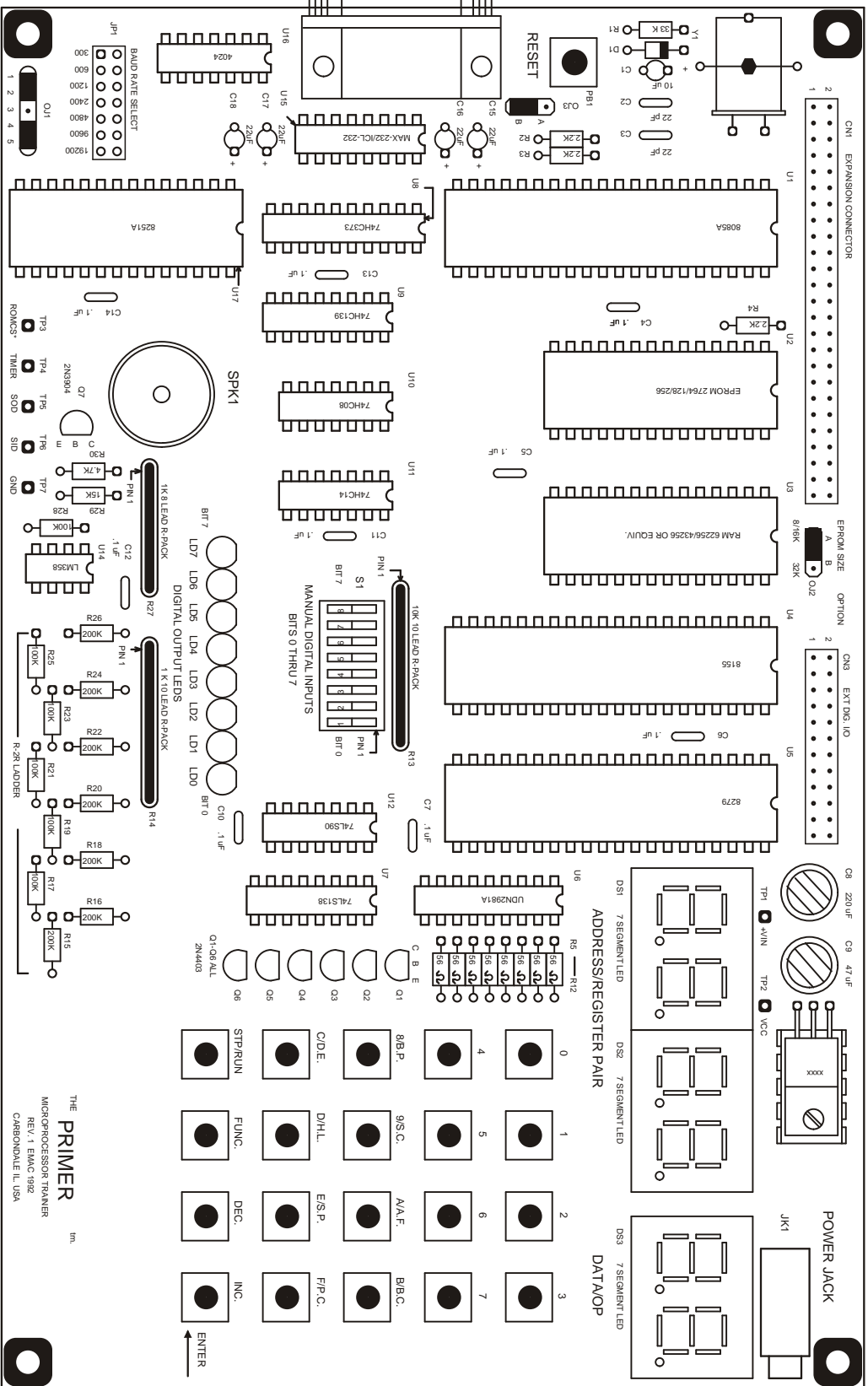

THE PRIMER
MICROPROCESSOR TRAINER
REV. 1 EMAC 1982
CARBONDALE IL USA

ASSEMBLY DRAWING H - OPTIONAL KEYPADS INSTALLED ON STANDARD BOARD INSTEAD OF BUTTONS

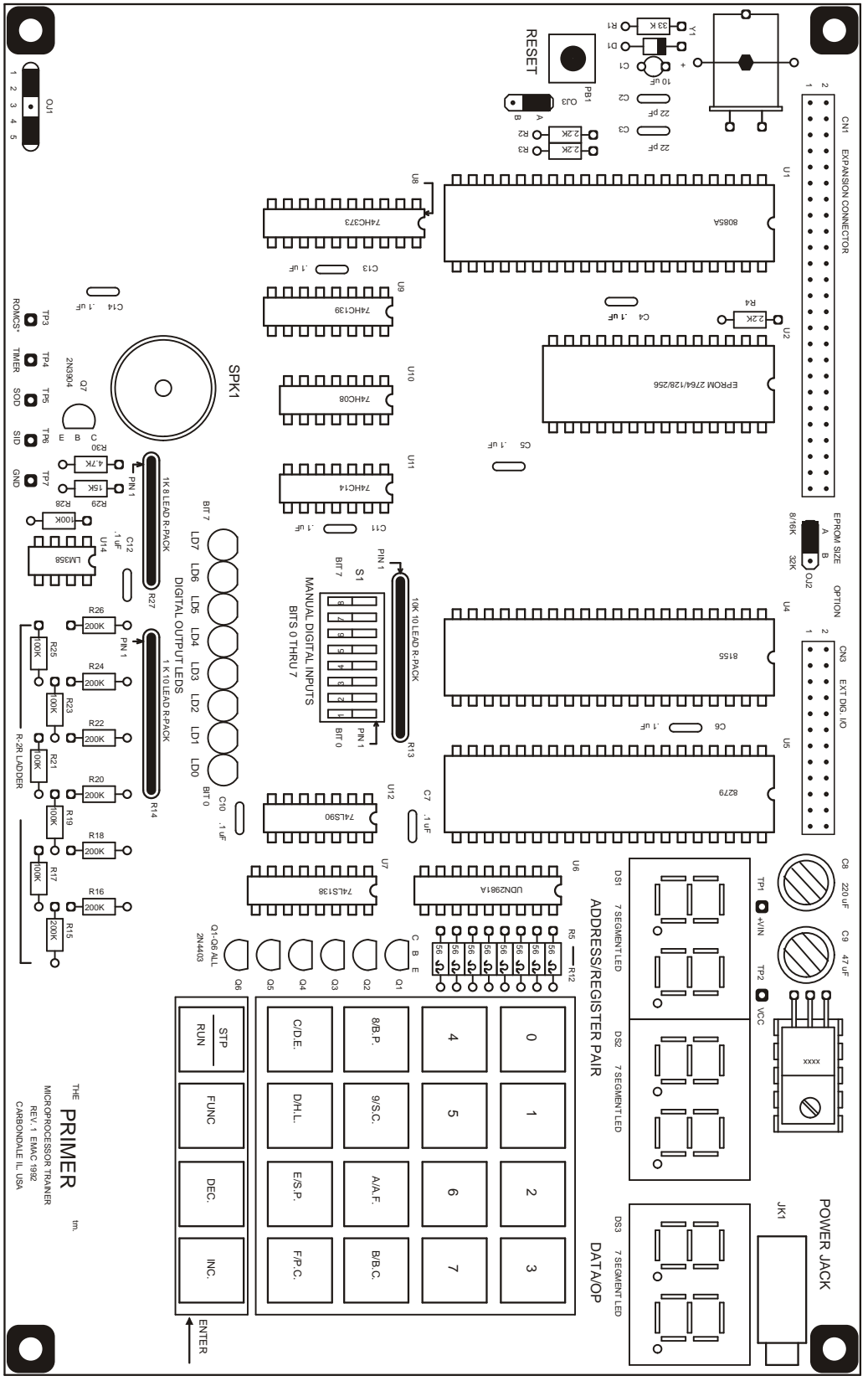

THE PRIMER
 MICROPROCESSOR TRAINER
 REV. 1 EMAC 1982
 CARBONDALE, IL, USA

ASSEMBLY DRAWING I - ALL OPTIONS INSTALLED PICTORAL

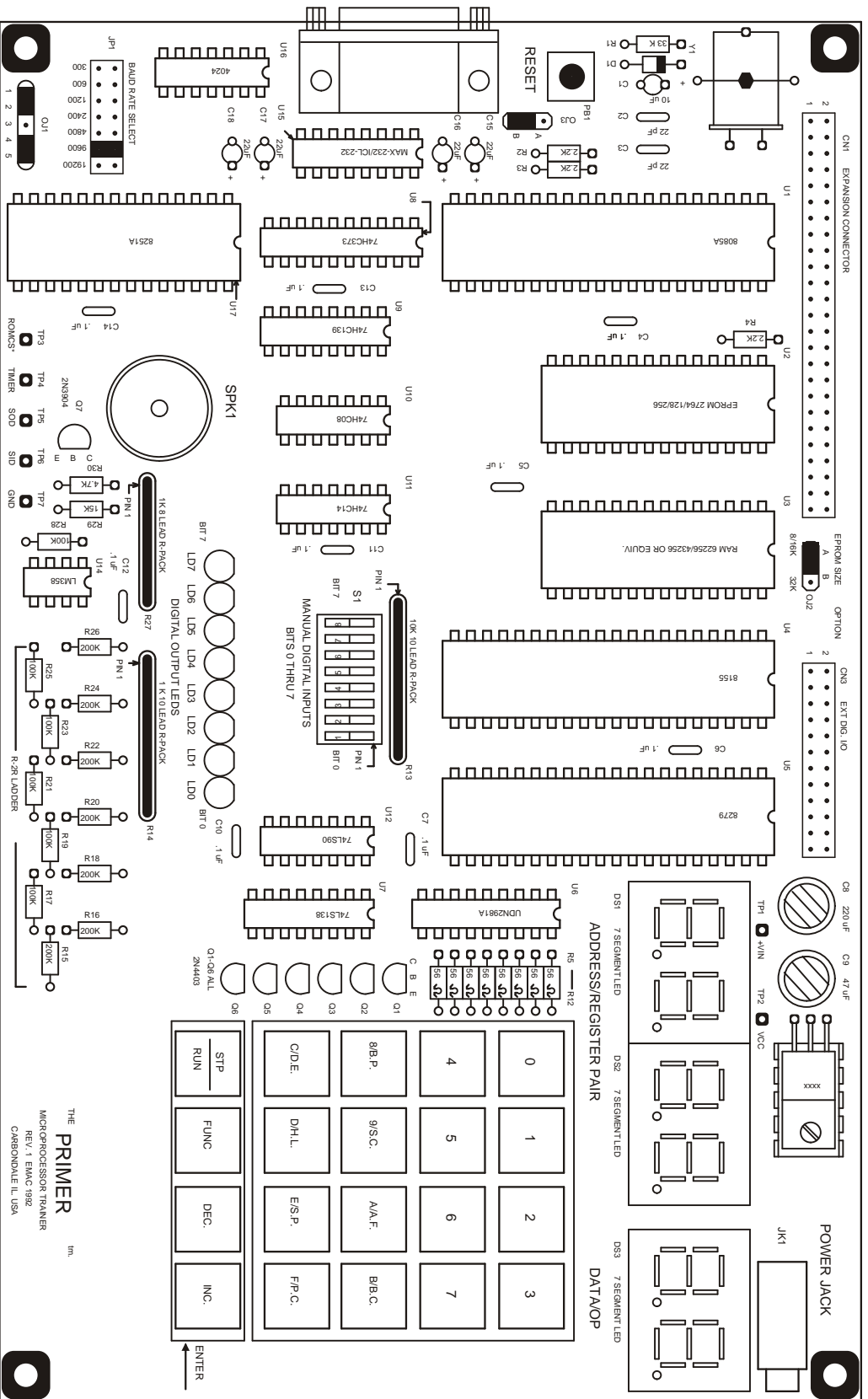

PRIMER 1P89
PRMR 1P83P5

FINAL ASSEMBLY

Again, Congratulations! You have now almost completely assembled your PRIMER board! Depending on the selections made regarding the keypad option, and communication/memory upgrade options, refer to the assembly drawings E, H, or I. These pictorials show how the board should look as completed.

Carefully inspect your completed board for correct placement of components, quality of soldering, etc. Be sure that all excess leads have been cleanly clipped. Carefully look at solder pads and circuit tracks for solder shorts, lead clip shorts, or tracks damaged due to careless lead clipping, etc. Most problems with the PRIMER, or any other circuit assembly, will come back to problems associated with improper assembly. Correct the problems found, and continue with the assembly.

It was suggested earlier (In Soldering Techniques) that you should use water soluble flux core solder. This new breed of solder leaves a readily cleanable residue. The older style rosin core solder residue requires flux removers to dissolve it, but the water soluble flux will rinse away with water. Whichever type of solder you used, it is time now to clean up the board. Using a fiber scrub brush, scrub the solder side of the board while dousing or spraying the board with the cleaning solvent. If you used water soluble flux, this may be accomplished by washing the board with water in the bathroom sink. Scrub the component side of the board, too, but do it gently so as not to bend over the parts, such as capacitors, transistors, and LEDs.

If you must use the solder that requires flux remover, clean up the board outdoors or in a well ventilated area so you don't have to breathe the fumes. Be aware the plastics used (in the LED Displays) may dissolve or discolor when the solvent touches them, so use the solvents carefully.

Far and away, the water soluble flux is the easiest, and best to use and clean up. Use a hair dryer to blow dry the boards when water is used to wash them. It takes a while to get all the water out from under the components, so be patient. If you have oil-free, dry compressed air available, use it to blast the moisture out from under the sockets, etc.

Under absolutely no circumstances, use a hair dryer on boards washed with solvent. The red hot coils in the hair dryer may ignite fumes, causing a fire or explosion. These boards should be air dried. The flux removers dry in 5 to 10 minutes.

Now that the board is clean, the final assembly step is to install the rubber feet onto the PRIMER. This step had to wait to last, as the feet must stick onto a clean, dry printed circuit board. Also, the flux remover (if used) would dissolve the rubber foot's adhesive. Assembly drawing "J" depicts the solder side of the PRIMER board, with the rubber feet in place. These positions are approximate, as there are no mounting holes for them. Perfect positioning is not important, as these feet are non conductive, and serve only to space the PRIMER board above the work table surface when the PRIMER is in use. The positions chosen are such that they will not interfere with the mounting holes, should they be used in the future, and to give the board good physical support as the buttons and switches are operated.

With a clean, fully assembled PRIMER board in hand, you are now ready to test your board.

ASSEMBLY DRAWING J - RUBBER FOOT PLACEMENT

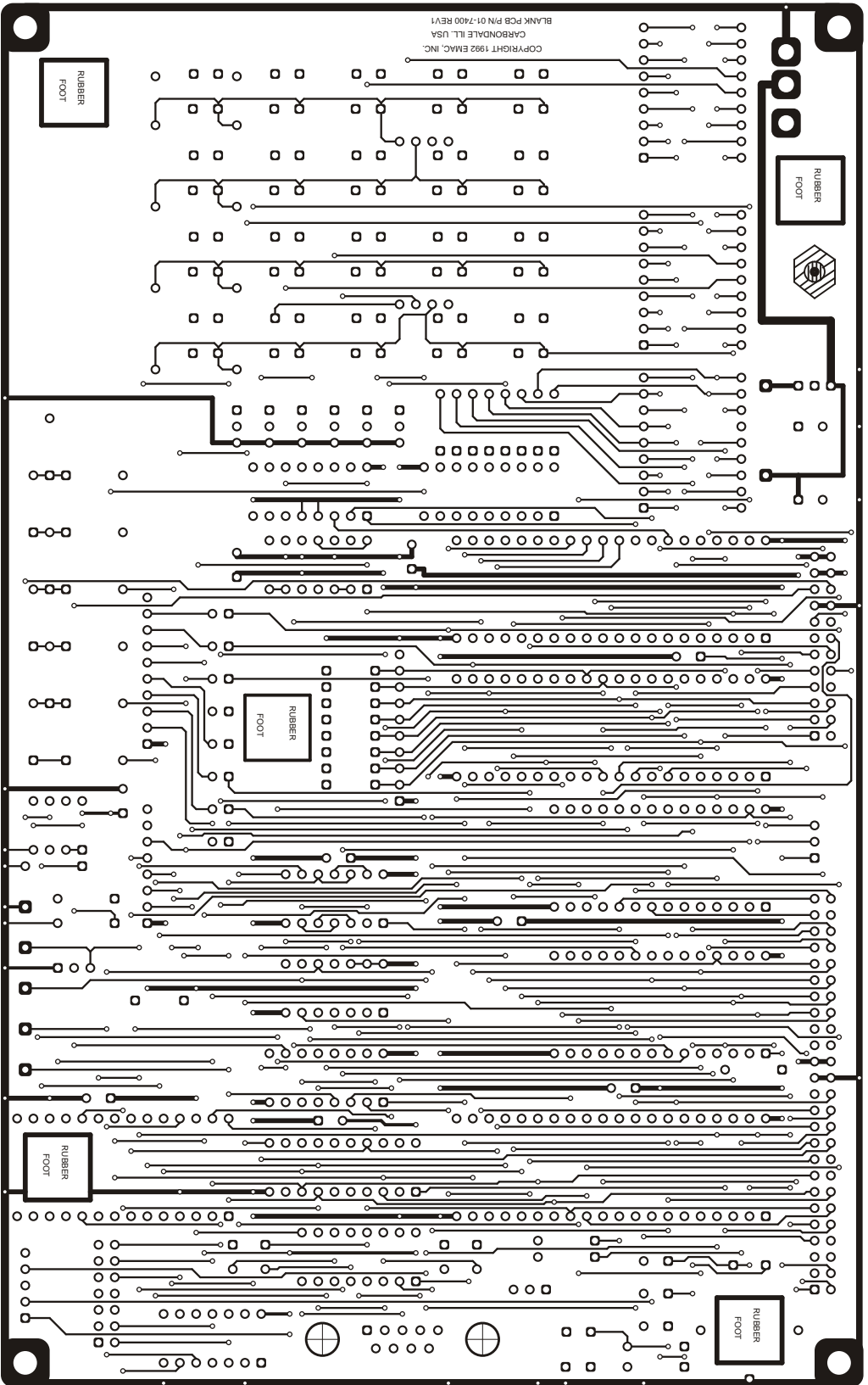

PLACE RUBBER FOOT PADS AT
THE FIVE PLACES INDICATED.

TESTING

[] 1. INITIAL POWER UP TEST

The PRIMER requires a 7 to 10 volt DC power supply input. The current requirement is approximately 480 mA. This may be taken from a bench power supply, the optional wall mount supply provided by EMAC, or any other suitable power source. A 9 volt transistor radio battery, however, cannot supply enough power.

To begin the first test of the PRIMER, install the Monitor Operating System (MOS) EPROM provided with the kit into the PRIMER's EPROM socket, U2. Make sure that Option Jumpers OJ2 and OJ3 are set to the "A" position when using the MOS EPROM. Connect the DC power supply to the power jack, JK1, being sure that the positive side of the power supply goes to the tip of the plug, and negative to the sleeve of the plug. If you have the nine volt DC power supply sold by EMAC, this has already been done for you. Plug the power supply into the wall outlet, or turn on your power source.

The PRIMER should produce a single "Beep" tone from the speaker, and the display should show "FF01" in the address display (leftmost four digits). The data display at the right can be anything, as long as both digits have a recognizable character in them (the display is of the random data that is in RAM upon power up). If the sound or display is not correct, immediately unplug the PRIMER.

If the PRIMER does not function correctly, unplug the power jack, and carefully re-check the board for proper assembly. Check the orientation, and placement of ICs, resistors, capacitors, etc. Carefully inspect the soldering, especially the connections to the 8085, 8155, the EPROM, and 8279 ICs. Solder shorts are very easy to miss in these areas. A clean board, and a bright light shone through from the component side will prove helpful in spotting solder shorts.

It is also possible the power supply is not functioning properly. Check it with a voltmeter if possible. Fortunately, the PRIMER is very forgiving electrically to mistakes. Once the problem is found and corrected, the PRIMER will usually not suffer damage if the fault is corrected quickly.

If using the MOS or EMOS EPROMs, a self test program is included. To use the self test, power up the primer and press the FUNC key followed by the numeric 1 key on the keypad. The self test program thoroughly tests each aspect of the primer and is explained in detail in the Getting Started section of the PRIMER SELF INSTRUCTION MANUAL. Other sections of this manual may also assist in trouble shooting. If you simply can't find the problem, you may wish to return the board to EMAC for repair. EMAC will correct the problem for no charge should the defect be due to a defective PC board, component, etc. However, we will charge a modest fee should the problem be caused by poor assembly.

Once your board is up and running, you are finished with assembly, and this manual. You may now proceed to using your PRIMER to learn about programming, and interfacing microprocessor systems. Good Luck!